





INSTRUCTIONS:

- 1.5 ct  
7.4mm 
- 1.25ct  
7.0mm 
- 1.00ct  
6.5mm 
- .75ct  
5.9mm 
- .50ct  
5.2mm 
- .33ct  
4.4mm 
- .25ct  
4.0mm 
- .20ct  
3.3mm 
- .15ct  
3.3mm 
- .10ct  
2.9mm 

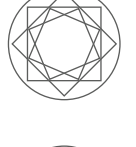
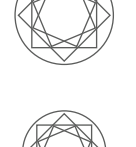
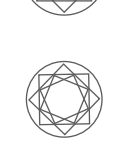
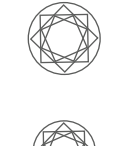
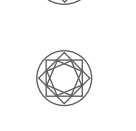
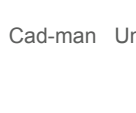
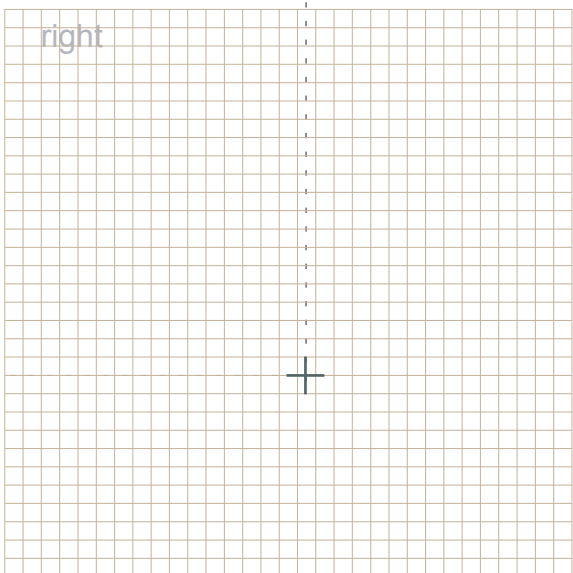
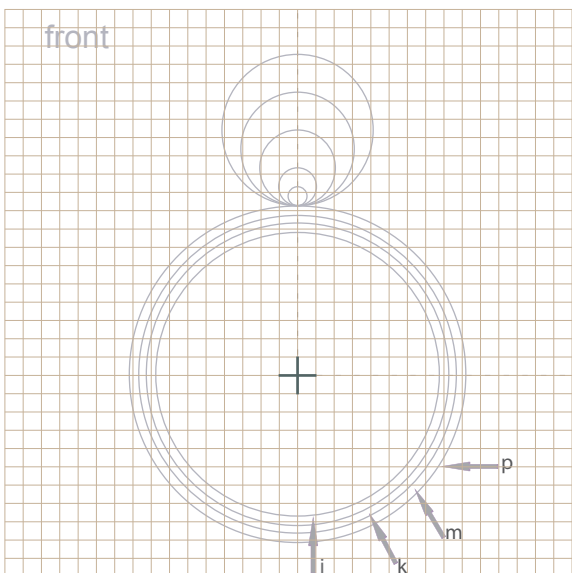
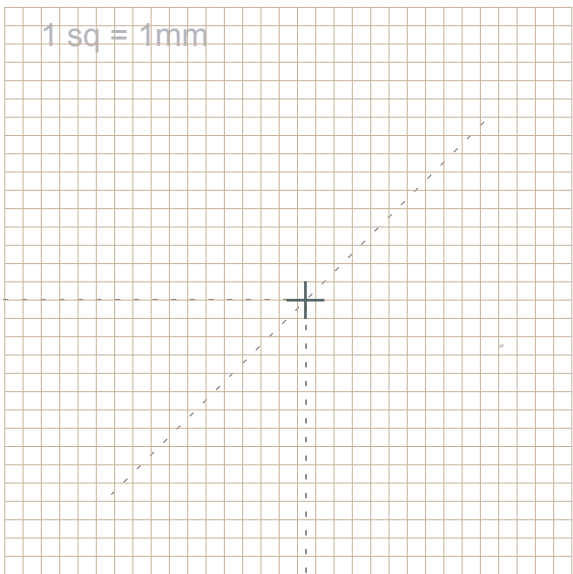
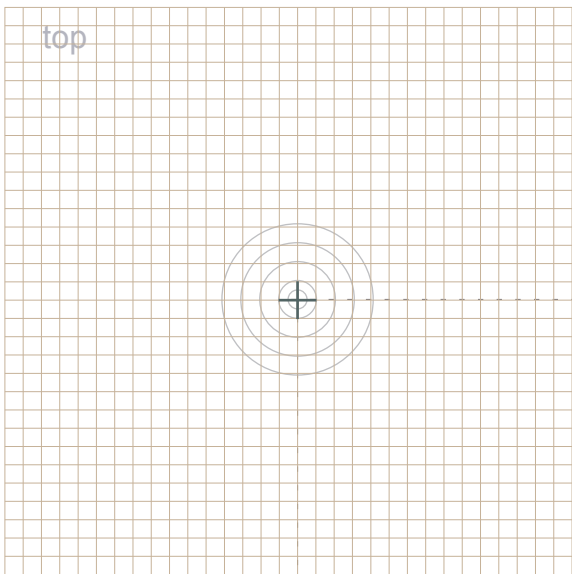

Metal:  
Finger size:  
Shank width:  
Shank thickness:

Date  
Name:  
Co:  
Tel:  
Email: